



FAR®

ELEKTRİK TEKNOLOJİLERİ A.Ş.

DAİMA İLERİ



2024

FİYAT LİSTESİ

www.far-electric.com.tr



FAR[®]

ELEKTRİK TEKNOLOJİLERİ A.Ş.

FAR Elektrik Teknolojileri
Türkiye' deki önde gelen üreticilerden ve ihracatçılardan biridir.

En son teknolojiyi izlemek ve müşteri taleplerini karşılamak
maksadıyla 1999' dan bu yana elektrik malzemeleri üretmekteyiz.

FAR, müşterilerin ihtiyaçlarına ve uluslararası rekabete göre
ürün yelpazesini genişletmiştir.
FAR, dünya çapında tanınan bir marka haline gelmek maksadıyla
3 kıtada ihracat olanakları ile sektörün kalite lideri olmak için
sürekli yeni adımlar atmaktadır.



İÇİNDEKİLER

01 • LARA GRUP PRİZ

02 • LARA GRUP PRİZ ÇOCUK KORUMA

03 • LARA GRUP PRİZ UPS

04 • LARA GRUP PRİZ TOPRAKSIZ

05
-
06 • UNIVERSAL SERİSİ

07 • 4'LÜ USB'Lİ
10'LU - 12'Lİ GRUP PRİZ

08 • GOLYAT SERİSİ

09
-
10 • AKSESUARLAR

11 • SIVA ALTI - ÜSTÜ ANH. PRİZ

12 • TEZGAH ALTI GRUP PRİZ

13 • KAUÇUK SERİSİ

14

15

16

17 • AYDINLATMA SERİSİ

18

19

20

21
-
22 • ACIL YÖNLENDİRME SERİSİ

23
-
24 • PLASTİK MALZEME SERİSİ

25 • KABLO KANALLARI SERİSİ

26 • SİGORTA KUTULARI

27 • SANAYİ TİPİ SERİSİ

**2'Lİ TOPRAKLI
GRUP PRİZ
LARA**



YENİ

KOD	SİP. KODU	ÜRÜN ADI	KUTU / KOLİ	FİYAT
F 290	15121000	2'li Grup Priz Klm.	20 / 120	77,00 TL
F 291 X	15121001	2'li Grup Priz 1 Mt.	12 / 72	176,00 TL
F 291 A	15121002	2'li Grup Priz 2 Mt.	12 / 72	208,00 TL
F 291 B	15121003	2'li Grup Priz 3 Mt.	12 / 72	250,00 TL
F 291 C	15121005	2'li Grup Priz 5 Mt.	12 / 48	336,00 TL
F 291 D	15121007	2'li Grup Priz 7 Mt.	12 / 12	437,00 TL
F 291 E	15121010	2'li Grup Priz 10 Mt.	12 / 12	570,00 TL

**2'Lİ TOPRAKLI
ANAHTARLI
GRUP PRİZ
LARA**



YENİ

KOD	SİP. KODU	ÜRÜN ADI	KUTU / KOLİ	FİYAT
F 292	15121100	2'li Anahtarlı Grup Priz Klm.	20 / 120	130,00 TL
F 293 X	15121101	2'li Anahtarlı Grup Priz 1 Mt.	12 / 72	230,00 TL
F 293 A	15121102	2'li Anahtarlı Grup Priz 2 Mt.	12 / 72	263,00 TL
F 293 B	15121103	2'li Anahtarlı Grup Priz 3 Mt.	12 / 72	305,00 TL
F 293 C	15121105	2'li Anahtarlı Grup Priz 5 Mt.	12 / 48	390,00 TL
F 293 D	15121107	2'li Anahtarlı Grup Priz 7 Mt.	12 / 12	510,00 TL
F 293 E	15121110	2'li Anahtarlı Grup Priz 10 Mt.	12 / 12	650,00 TL

**3'LÜ TOPRAKLI
GRUP PRİZ
LARA**



**3'LÜ TOPRAKLI
ANAHTARLI
GRUP PRİZ
LARA**



KOD	SİP. KODU	ÜRÜN ADI	KUTU / KOLİ	FİYAT
F 500	15131000	3'lü Grup Priz Klm.(LARA)	20 / 120	90,00 TL
F 501 X	15131001	3'lü Grup Priz 1 Mt.	12 / 72	195,00 TL
F 501 A	15131002	3'lü Grup Priz 2 Mt.	12 / 72	230,00 TL
F 501 B	15131003	3'lü Grup Priz 3 Mt.	12 / 72	271,00 TL
F 501 C	15131005	3'lü Grup Priz 5 Mt.	12 / 48	357,00 TL
F 501 D	15131007	3'lü Grup Priz 7 Mt.	12 / 12	547,00 TL
F 501 E	15131010	3'lü Grup Priz 10 Mt.	12 / 12	610,00 TL

KOD	SİP. KODU	ÜRÜN ADI	KUTU / KOLİ	FİYAT
F 502	15131100	3'lü Anahtarlı Grup Priz Klm.	20 / 120	146,00 TL
F 503 X	15131101	3'lü Anahtarlı Grup Priz 1 Mt.	12 / 72	252,00 TL
F 503 A	15131102	3'lü Anahtarlı Grup Priz 2 Mt.	12 / 72	285,00 TL
F 503 B	15131103	3'lü Anahtarlı Grup Priz 3 Mt.	12 / 72	325,00 TL
F 503 C	15131105	3'lü Anahtarlı Grup Priz 5 Mt.	12 / 48	412,00 TL
F 503 D	15131107	3'lü Anahtarlı Grup Priz 7 Mt.	12 / 12	530,00 TL
F 503 E	15131110	3'lü Anahtarlı Grup Priz 10 Mt.	12 / 12	670,00 TL

**4'LÜ TOPRAKLI
GRUP PRİZ
LARA**



**4'LÜ TOPRAKLI
ANAHTARLI
GRUP PRİZ
LARA**



KOD	SİP. KODU	ÜRÜN ADI	KUTU / KOLİ	FİYAT
F 504	15141000	4'lü Grup Priz Klm.	20 / 120	120,00 TL
F 505 A	15141002	4'lü Grup Priz 2 Mt.	12 / 48	257,00 TL
F 505 B	15141003	4'lü Grup Priz 3 Mt.	12 / 48	300,00 TL
F 505 C	15141005	4'lü Grup Priz 5 Mt.	12 / 48	400,00 TL
F 505 D	15141007	4'lü Grup Priz 7 Mt.	12 / 12	520,00 TL
F 505 E	15141010	4'lü Grup Priz 10 Mt.	12 / 12	665,00 TL

KOD	SİP. KODU	ÜRÜN ADI	KUTU / KOLİ	FİYAT
F 506	15141100	4'lü Anahtarlı Grup Priz Klm.	20 / 120	172,00 TL
F 507 A	15141102	4'lü Anahtarlı Grup Priz 2 Mt.	12 / 48	318,00 TL
F 507 B	15141103	4'lü Anahtarlı Grup Priz 3 Mt.	12 / 48	360,00 TL
F 507 C	15141105	4'lü Anahtarlı Grup Priz 5 Mt.	12 / 48	455,00 TL
F 507 D	15141107	4'lü Anahtarlı Grup Priz 7 Mt.	12 / 12	580,00 TL
F 507 E	15141110	4'lü Anahtarlı Grup Priz 10 Mt.	12 / 12	720,00 TL

**6'LI TOPRAKLI
GRUP PRİZ
LARA**



**6'LI TOPRAKLI
ANAHTARLI
GRUP PRİZ
LARA**



KOD	SİP. KODU	ÜRÜN ADI	KUTU / KOLİ	FİYAT
F 508	15161000	6'lı Grup Priz Klm.	15 / 90	175,00 TL
F 509 A	15161002	6'lı Grup Priz 2 Mt.	12 / 48	315,00 TL
F 509 B	15161003	6'lı Grup Priz 3 Mt.	12 / 48	360,00 TL
F 509 C	15161005	6'lı Grup Priz 5 Mt.	12 / 48	450,00 TL
F 509 D	15161007	6'lı Grup Priz 7 Mt.	12 / 12	570,00 TL
F 509 E	15161010	6'lı Grup Priz 10 Mt.	12 / 12	730,00 TL

KOD	SİP. KODU	ÜRÜN ADI	KUTU / KOLİ	FİYAT
F 510	15161100	6'lı Anahtarlı Grup Priz Klm.	15 / 90	227,00 TL
F 511 A	15161102	6'lı Anahtarlı Grup Priz 2 Mt.	12 / 48	370,00 TL
F 511 B	15161103	6'lı Anahtarlı Grup Priz 3 Mt.	12 / 48	415,00 TL
F 511 C	15161105	6'lı Anahtarlı Grup Priz 5 Mt.	12 / 48	508,00 TL
F 511 D	15161107	6'lı Anahtarlı Grup Priz 7 Mt.	12 / 12	637,00 TL
F 511 E	15161110	6'lı Anahtarlı Grup Priz 10 Mt.	12 / 12	785,00 TL



LARA SERİSİ



KOD	SİP. KODU	ÜRÜN ADI	KUTU / KOLİ	FİYAT
F 267	15031000	3'lü Grup Priz Klm.	20 / 120	102,00 TL
F 268 X	15031001	3'lü Grup Priz 1 Mt.	12 / 72	207,00 TL
F 268 A	15031002	3'lü Grup Priz 2 Mt.	12 / 72	246,00 TL
F 268 B	15031003	3'lü Grup Priz 3 Mt.	12 / 72	290,00 TL
F 268 C	15031005	3'lü Grup Priz 5 Mt.	12 / 48	382,00 TL
F 268 D	15031007	3'lü Grup Priz 7 Mt.	12 / 12	487,00 TL
F 268 E	15031010	3'lü Grup Priz 10 Mt.	12 / 12	645,00 TL

KOD	SİP. KODU	ÜRÜN ADI	KUTU / KOLİ	FİYAT
F 269	15031100	3'lü Anahtarlı Grup Priz Klm.	20 / 120	155,00 TL
F 270 X	15031101	3'lü Anahtarlı Grup Priz 1 Mt.	12 / 72	266,00 TL
F 270 A	15031102	3'lü Anahtarlı Grup Priz 2 Mt.	12 / 72	305,00 TL
F 270 B	15031103	3'lü Anahtarlı Grup Priz 3 Mt.	12 / 72	348,00 TL
F 270 C	15031105	3'lü Anahtarlı Grup Priz 5 Mt.	12 / 48	440,00 TL
F 270 D	15031107	3'lü Anahtarlı Grup Priz 7 Mt.	12 / 12	545,00 TL
F 270 E	15031110	3'lü Anahtarlı Grup Priz 10 Mt.	12 / 12	703,00 TL

KOD	SİP. KODU	ÜRÜN ADI	KUTU / KOLİ	FİYAT
F 271	15041000	4'lü Grup Priz Klm.	20 / 120	133,00 TL
F 272 A	15041002	4'lü Grup Priz 2 Mt.	12 / 48	290,00 TL
F 272 B	15041003	4'lü Grup Priz 3 Mt.	12 / 48	334,00 TL
F 272 C	15041005	4'lü Grup Priz 5 Mt.	12 / 48	427,00 TL
F 272 D	15041007	4'lü Grup Priz 7 Mt.	12 / 12	553,00 TL
F 272 E	150410010	4'lü Grup Priz 10 Mt.	12 / 12	700,00 TL

KOD	SİP. KODU	ÜRÜN ADI	KUTU / KOLİ	FİYAT
F 273	15041100	4'lü Anahtarlı Grup Priz Klm.	20 / 120	184,00 TL
F 274 A	15041102	4'lü Anahtarlı Grup Priz 2 Mt.	12 / 48	347,00 TL
F 274 B	15041103	4'lü Anahtarlı Grup Priz 3 Mt.	12 / 48	393,00 TL
F 274 C	15041105	4'lü Anahtarlı Grup Priz 5 Mt.	12 / 48	485,00 TL
F 274 D	15041107	4'lü Anahtarlı Grup Priz 7 Mt.	12 / 12	614,00 TL
F 274 E	15041110	4'lü Anahtarlı Grup Priz 10 Mt.	12 / 12	761,00 TL

KOD	SİP. KODU	ÜRÜN ADI	KUTU / KOLİ	FİYAT
F 275	15061000	6'lı Grup Priz Klm.	15 / 90	186,00 TL
F 276 A	15061002	6'lı Grup Priz 2 Mt.	12 / 48	333,00 TL
F 276 B	15061003	6'lı Grup Priz 3 Mt.	12 / 48	379,00 TL
F 276 C	15061005	6'lı Grup Priz 5 Mt.	12 / 48	471,00 TL
F 276 D	15061007	6'lı Grup Priz 7 Mt.	12 / 12	600,00 TL
F 276 E	15061010	6'lı Grup Priz 10 Mt.	12 / 12	747,00 TL

KOD	SİP. KODU	ÜRÜN ADI	KUTU / KOLİ	FİYAT
F 277	15061100	6'lı Anahtarlı Grup Priz Klm.	15 / 90	240,00 TL
F 278 A	15061102	6'lı Anahtarlı Grup Priz 2 Mt.	12 / 48	392,00 TL
F 278 B	15061103	6'lı Anahtarlı Grup Priz 3 Mt.	12 / 48	437,00 TL
F 278 C	15061105	6'lı Anahtarlı Grup Priz 5 Mt.	12 / 48	529,00 TL
F 278 D	15061107	6'lı Anahtarlı Grup Priz 7 Mt.	12 / 12	659,00 TL
F 278 E	15061110	6'lı Anahtarlı Grup Priz 10 Mt.	12 / 12	807,00 TL



3'LÜ TOPRAKLI
GRUP PRİZ
ÇOCUK KORUMALI



3'LÜ TOPRAKLI
ANAHTARLI
GRUP PRİZ
ÇOCUK KORUMALI



4'LÜ TOPRAKLI
GRUP PRİZ
ÇOCUK KORUMALI



4'LÜ TOPRAKLI
ANAHTARLI
GRUP PRİZ
ÇOCUK KORUMALI



6'LI TOPRAKLI
GRUP PRİZ
ÇOCUK KORUMALI



6'LI TOPRAKLI
ANAHTARLI
GRUP PRİZ
ÇOCUK KORUMALI



LARA UPS SERİSİ

Turkey
Discover
the potential**3'LÜ UPS'Lİ
GRUP PRİZ
(FRANSIZ SİSTEMİ)**

KOD	SİR KODU	ÜRÜN ADI	KUTU / KOLİ	FİYAT
F 56	15132000	3'lü Ups Grup Priz Klm.	20 / 120	115,00 TL
F 57A	15132002	3'lü Ups Grup Priz 2 Mt.	12 / 72	266,00 TL
F 57B	15132003	3'lü Ups Grup Priz 3 Mt.	12 / 72	312,00 TL
F 57C	15132005	3'lü Ups Grup Priz 5 Mt.	12 / 48	422,00 TL

**3'LÜ UPS'Lİ
ANAHTARLI
GRUP PRİZ
(FRANSIZ SİSTEMİ)**

KOD	SİR KODU	ÜRÜN ADI	KUTU / KOLİ	FİYAT
F 74	15132100	3'lü Anah. Ups Grup Priz Klm.	20 / 120	179,00 TL
F 75A	15132102	3'lü Anah. Ups Grup Priz 2 Mt.	12 / 72	322,00 TL
F 75B	15132103	3'lü Anah. Ups Grup Priz 3 Mt.	12 / 72	380,00 TL
F 75C	15132105	3'lü Anah. Ups Grup Priz 5 Mt.	12 / 48	476,00 TL

**4'LÜ UPS'Lİ
GRUP PRİZ
(FRANSIZ SİSTEMİ)**

KOD	SİR KODU	ÜRÜN ADI	KUTU / KOLİ	FİYAT
F 58	15142000	4'lü Ups Grup Priz Klm.	20 / 120	152,00 TL
F 59A	15142002	4'lü Ups Grup Priz 2 Mt.	12 / 48	299,00 TL
F 59B	15142003	4'lü Ups Grup Priz 3 Mt.	12 / 48	356,00 TL
F 59C	15142005	4'lü Ups Grup Priz 5 Mt.	12 / 48	452,00 TL

**4'LÜ UPS'Lİ
ANAHTARLI
GRUP PRİZ
(FRANSIZ SİSTEMİ)**

KOD	SİR KODU	ÜRÜN ADI	KUTU / KOLİ	FİYAT
F 76	15142100	4'lü Anah. Ups Grup Priz Klm.	20 / 120	214,00 TL
F 77A	15142102	4'lü Anah. Ups Grup Priz 2 Mt.	12 / 48	357,00 TL
F 77B	15142103	4'lü Anah. Ups Grup Priz 3 Mt.	12 / 48	416,00 TL
F 77C	15142105	4'lü Anah. Ups Grup Priz 5 Mt.	12 / 48	512,00 TL

**6'Lİ UPS'Lİ
GRUP PRİZ
(FRANSIZ SİSTEMİ)**

KOD	SİR KODU	ÜRÜN ADI	KUTU / KOLİ	FİYAT
F 60	15162000	6'lü Ups Grup Priz Klm.	15 / 90	205,00 TL
F 61A	15162002	6'lü Ups Grup Priz 2 Mt.	12 / 48	345,00 TL
F 61B	15162003	6'lü Ups Grup Priz 3 Mt.	12 / 48	405,00 TL
F 61C	15162005	6'lü Ups Grup Priz 5 Mt.	12 / 48	500,00 TL

**6'Lİ UPS'Lİ
ANAHTARLI
GRUP PRİZ
(FRANSIZ SİSTEMİ)**

KOD	SİR KODU	ÜRÜN ADI	KUTU / KOLİ	FİYAT
F 78	15162100	6'lü Anah. Ups Grup Priz Klm.	15 / 90	261,00 TL
F 79A	15162102	6'lü Anah. Ups Grup Priz 2 Mt.	12 / 48	404,00 TL
F 79B	15162103	6'lü Anah. Ups Grup Priz 3 Mt.	12 / 48	465,00 TL
F 79C	15162105	6'lü Anah. Ups Grup Priz 5 Mt.	12 / 48	561,00 TL



TOPRAKSIZ GRUP SERİSİ



KOD	SİP. KODU	ÜRÜN ADI	KUTU / KOLİ	FİYAT
F 141	10030000	3'lü Topraksız Grup Priz Klm.	20 / 200	52,80 TL
F 142A	10030002	3'lü Topraksız Grup Priz 2 Mt.	12 / 48	147,00 TL
F 142B	10030003	3'lü Topraksız Grup Priz 3 Mt.	12 / 48	174,00 TL
F 142C	10030005	3'lü Topraksız Grup Priz 5 Mt.	12 / 48	227,00 TL



**3'LÜ TOPRAKSIZ
GRUP PRİZ
MANOLYA**

KOD	SİP. KODU	ÜRÜN ADI	KUTU / KOLİ	FİYAT
F 283	15030000	3'lü Topraksız Grup Priz Klm.	30 / 180	75,50 TL
F 284A	15030002	3'lü Topraksız Grup Priz 2 Mt.	12 / 48	168,00 TL
F 284B	15030003	3'lü Topraksız Grup Priz 3 Mt.	12 / 48	195,00 TL
F 284C	15030005	3'lü Topraksız Grup Priz 5 Mt.	12 / 48	250,00 TL



**3'LÜ TOPRAKSIZ
GRUP PRİZ
LARA**

KOD	SİP. KODU	ÜRÜN ADI	KUTU / KOLİ	FİYAT
F 202	15040000	4'lü Topraksız Grup Priz Klm.	20 / 120	94,00 TL
F 203A	15040002	4'lü Topraksız Grup Priz 2 Mt.	12 / 48	181,00 TL
F 203B	15040003	4'lü Topraksız Grup Priz 3 Mt.	12 / 48	208,00 TL
F 203C	15040005	4'lü Topraksız Grup Priz 5 Mt.	12 / 48	262,00 TL

YENİ



**4'LÜ TOPRAKSIZ
GRUP PRİZ
LARA**

KOD	SİP. KODU	ÜRÜN ADI	KUTU / KOLİ	FİYAT
F 204	15040100	4'lü Anh. Topraksız Grup Priz Klm.	20 / 120	149,00 TL
F 205A	15040102	4'lü Anh. Topraksız Grup Priz 2 Mt.	12 / 48	246,00 TL
F 205B	15040103	4'lü Anh. Topraksız Grup Priz 3 Mt.	12 / 48	273,00 TL
F 205C	15040105	4'lü Anh. Topraksız Grup Priz 5 Mt.	12 / 48	327,00 TL

YENİ



**4'LÜ TOPRAKSIZ
ANAHTARLI
GRUP PRİZ
LARA**

KOD	SİP. KODU	ÜRÜN ADI	KUTU / KOLİ	FİYAT
F 20	15060000	6'lı Topraksız Grup Priz Klm.	15 / 90	114,00 TL
F 21A	15060002	6'lı Topraksız Grup Priz 2 Mt.	12 / 48	206,00 TL
F 21B	15060003	6'lı Topraksız Grup Priz 3 Mt.	12 / 48	233,00 TL
F 21C	15060005	6'lı Topraksız Grup Priz 5 Mt.	12 / 48	287,00 TL

YENİ



**6'Lİ TOPRAKSIZ
GRUP PRİZ
LARA**

KOD	SİP. KODU	ÜRÜN ADI	KUTU / KOLİ	FİYAT
F 22	15060100	6'lı Anh. Topraksız Grup Priz Klm.	15 / 90	169,00 TL
F 23A	15060102	6'lı Anh. Topraksız Grup Priz 2 Mt.	12 / 48	267,00 TL
F 23B	15060103	6'lı Anh. Topraksız Grup Priz 3 Mt.	12 / 48	294,00 TL
F 23C	15060105	6'lı Anh. Topraksız Grup Priz 5 Mt.	12 / 48	348,00 TL

YENİ



**6'Lİ TOPRAKSIZ
ANAHTARLI
GRUP PRİZ
LARA**

KOD	SİP. KODU	ÜRÜN ADI	KUTU / KOLİ	FİYAT
F 19A	12001003	Uzatma Takımı 3 Mt.	16 / 64	231,00 TL
F 19B	12001005	Uzatma Takımı 5 Mt.	16 / 64	330,00 TL
F 19C	12001010	Uzatma Takımı 10 Mt.	16 / 16	572,00 TL
F 19D	12001015	Uzatma Takımı 15 Mt.	12 / 12	892,00 TL

**UZATMA
TAKIMI**



UNIVERSAL SERİSİ

Turkey
Discover
the potential2'Lİ GRUP PRİZ
UNIVERSAL

KOD	SİP KODU	ÜRÜN ADI	KUTU / KOLİ	FİYAT
F 183	13021000	2'li Grup Priz Klm.	20 / 120	132,00 TL
F 184A	13021002	2'li Grup Priz 2 Mt.	12 / 72	253,00 TL
F 184B	13021003	2'li Grup Priz 3 Mt.	12 / 72	295,00 TL
F 184C	13021005	2'li Grup Priz 5 Mt.	12 / 48	381,00 TL

2'Lİ ANAHTARLI
GRUP PRİZ
UNIVERSAL

KOD	SİP KODU	ÜRÜN ADI	KUTU / KOLİ	FİYAT
F 185	13021100	2'li Anahtarlı Grup Priz Klm.	20 / 120	182,00 TL
F 186A	13021102	2'li Anahtarlı Grup Priz 2 Mt.	12 / 72	315,00 TL
F 186B	13021103	2'li Anahtarlı Grup Priz 3 Mt.	12 / 72	357,00 TL
F 186C	13021105	2'li Anahtarlı Grup Priz 5 Mt.	12 / 48	444,00 TL

2+2 GRUP PRİZ
UNIVERSAL

KOD	SİP KODU	ÜRÜN ADI	KUTU / KOLİ	FİYAT
F 195	14041000	2+2 Grup Priz Klm.	20 / 120	183,00 TL
F 196A	14041002	2+2 Grup Priz 2 Mt.	12 / 48	313,00 TL
F 196B	14041003	2+2 Grup Priz 3 Mt.	12 / 48	356,00 TL
F 196C	14041005	2+2 Grup Priz 5 Mt.	12 / 48	442,00 TL

2+2 ANAHTARLI
GRUP PRİZ
UNIVERSAL

KOD	SİP KODU	ÜRÜN ADI	KUTU / KOLİ	FİYAT
F 197	14041100	2+2 Anahtarlı Grup Priz Klm.	20 / 120	239,00 TL
F 198A	14041102	2+2 Anahtarlı Grup Priz 2 Mt.	12 / 48	376,00 TL
F 198B	14041103	2+2 Anahtarlı Grup Priz 3 Mt.	12 / 48	418,00 TL
F 198C	14041105	2+2 Anahtarlı Grup Priz 5 Mt.	12 / 48	505,00 TL

3'LÜ GRUP PRİZ
UNIVERSAL

KOD	SİP KODU	ÜRÜN ADI	KUTU / KOLİ	FİYAT
F 187	13031000	3'lü Grup Priz Klm.	20 / 120	161,00 TL
F 188A	13031002	3'lü Grup Priz 2 Mt.	12 / 72	291,00 TL
F 188B	13031003	3'lü Grup Priz 3 Mt.	12 / 72	333,00 TL
F 188C	13031005	3'lü Grup Priz 5 Mt.	12 / 48	420,00 TL

3'LÜ ANAHTARLI
GRUP PRİZ
UNIVERSAL

KOD	SİP KODU	ÜRÜN ADI	KUTU / KOLİ	FİYAT
F 189	13031100	3'lü Anahtarlı Grup Priz Klm.	20 / 120	221,00 TL
F 190A	13031102	3'lü Anahtarlı Grup Priz 2 Mt.	12 / 72	354,00 TL
F 190B	13031103	3'lü Anahtarlı Grup Priz 3 Mt.	12 / 72	396,00 TL
F 190C	13031105	3'lü Anahtarlı Grup Priz 5 Mt.	12 / 48	482,00 TL



UNIVERSAL SERİSİ

Turkey
Discover
the potentialYERLİ
ÜRETİM

KOD	SİP KODU	ÜRÜN ADI	KUTU / KOLİ	FİYAT
F 300	14061000	3+3 Grup Priz Klm.	20 / 80	241,00 TL
F 301A	14061002	3+3 Grup Priz 2 Mt	12 / 48	370,00 TL
F 301B	14061003	3+3 Grup Priz 3 Mt	12 / 48	412,00 TL
F 301C	14061005	3+3 Grup Priz 5 Mt	12 / 48	498,00 TL

3+3 GRUP PRİZ
UNIVERSAL

KOD	SİP KODU	ÜRÜN ADI	KUTU / KOLİ	FİYAT
F 302	14061100	3+3 Anahtarlı Grup Priz Klm.	20 / 80	296,00 TL
F 303A	14061102	3+3 Anahtarlı Grup Priz 2 Mt	12 / 48	436,00 TL
F 303B	14061103	3+3 Anahtarlı Grup Priz 3 Mt	12 / 48	478,00 TL
F 303C	14061105	3+3 Anahtarlı Grup Priz 5 Mt	12 / 48	565,00 TL

3+3 ANAHTARLI
GRUP PRİZ
UNIVERSAL

KOD	SİP KODU	ÜRÜN ADI	KUTU / KOLİ	FİYAT
F 191	13041000	4'lü Grup Priz Klm.	20 / 120	199,00 TL
F 192A	13041002	4'lü Grup Priz 2 Mt.	12 / 48	329,00 TL
F 192B	13041003	4'lü Grup Priz 3 Mt.	12 / 48	371,00 TL
F 192C	13041005	4'lü Grup Priz 5 Mt.	12 / 48	457,00 TL

4'LÜ GRUP PRİZ
UNIVERSAL

KOD	SİP KODU	ÜRÜN ADI	KUTU / KOLİ	FİYAT
F 193	13041100	4'lü Anahtarlı Grup Priz Klm.	20 / 120	258,00 TL
F 194A	13041102	4'lü Anahtarlı Grup Priz 2 Mt.	12 / 48	391,00 TL
F 194B	13041103	4'lü Anahtarlı Grup Priz 3 Mt.	12 / 48	434,00 TL
F 194C	13041105	4'lü Anahtarlı Grup Priz 5 Mt.	12 / 48	520,00 TL

4'LÜ ANAHTARLI
GRUP PRİZ
UNIVERSAL

KOD	SİP KODU	ÜRÜN ADI	KUTU / KOLİ	FİYAT
F 304	13061000	6'lı Grup Priz Klm.	20 / 80	272,00 TL
F 305A	13061002	6'lı Grup Priz 2 Mt	12 / 48	410,00 TL
F 305B	13061003	6'lı Grup Priz 3 Mt	12 / 48	451,00 TL
F 305C	13061005	6'lı Grup Priz 5 Mt	12 / 48	537,00 TL

6'LI GRUP PRİZ
UNIVERSAL

KOD	SİP KODU	ÜRÜN ADI	KUTU / KOLİ	FİYAT
F 306	13061100	6'lı Anahtarlı Grup Priz Klm.	20 / 80	334,00 TL
F 307A	13061102	6'lı Anahtarlı Grup Priz 2 Mt	12 / 48	480,00 TL
F 307B	13061103	6'lı Anahtarlı Grup Priz 3 Mt	12 / 48	523,00 TL
F 307C	13061105	6'lı Anahtarlı Grup Priz 5 Mt	12 / 48	610,00 TL

6'LI ANAHTARLI
GRUP PRİZ
UNIVERSAL

LARA SERİSİ

4'LÜ GRUP PRİZ 2 USB'Lİ

Kod : F 512 A
Sip. Kod : 15141202
Kutu / Koli : 12/48



2 METRE
570,00 TL

Kod : F 512 B
Sip. Kod : 15141203
Kutu / Koli : 12/48

3 METRE
640,00 TL

Kod : F 512 C
Sip. Kod : 15141205
Kutu / Koli : 12/48

5 METRE
730,00 TL

12'Lİ GRUP PRİZ

Kod : F 150
Sip. Kod : 11121000
Kutu / Koli : 15/60



570,00 TL

10'LU GRUP PRİZ

Kod : F 62
Sip. Kod : 15101000
Kutu / Koli : 15/60



420,00 TL

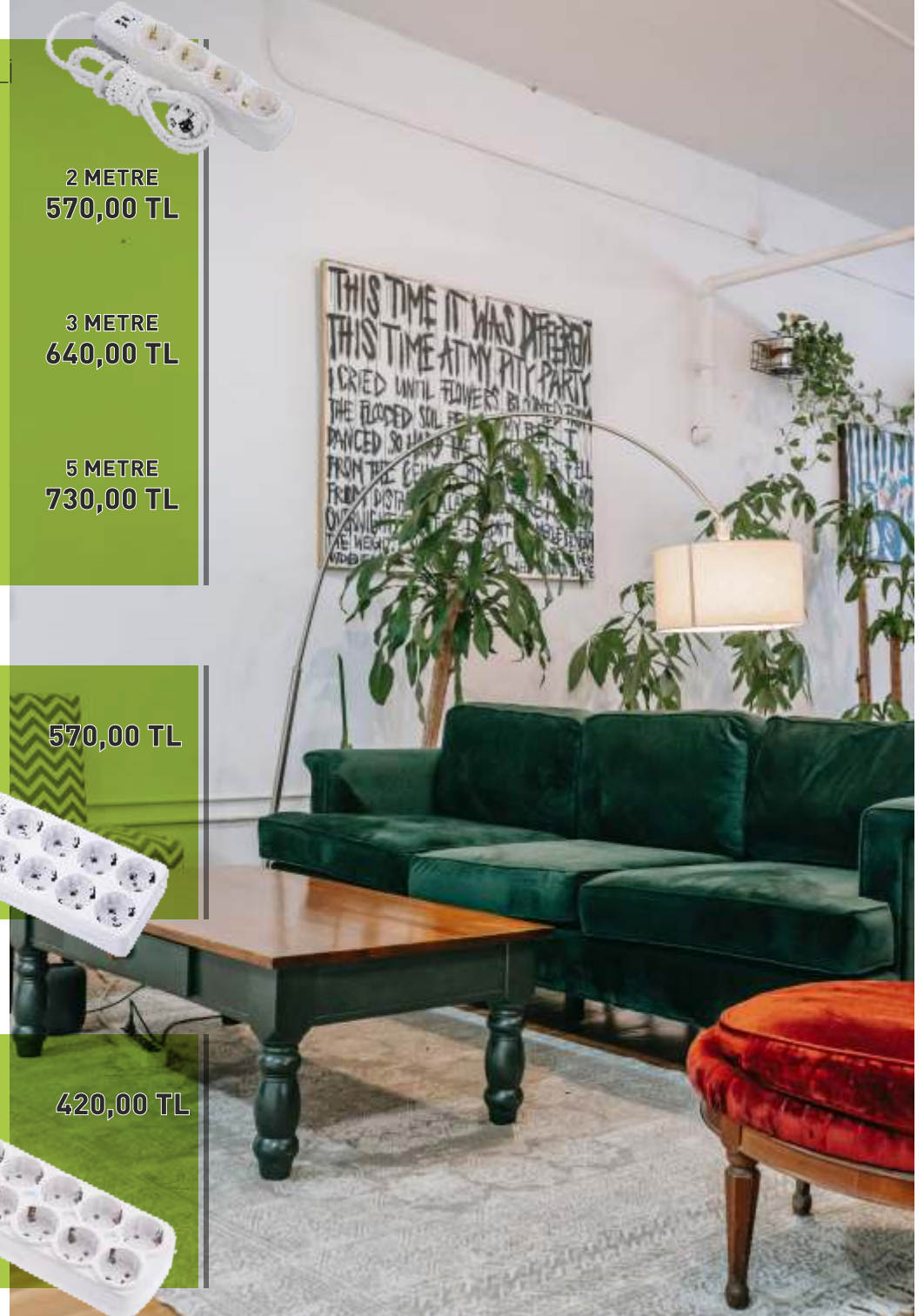

GOLYAT SERİSİ

Turkey
Discover
the potentialYERLİ
ÜRETİM

F 285

2'Lİ ANAHTARLI AKIM
KORUMALI GOLYAT

KOD	KUTU / KOLİ	FİYAT
19111285	20 / 80	400,00 TL

F 08

2 USB'Lİ 3'LÜ
FİŞ PRİZ GOLYAT

KOD	KUTU / KOLİ	FİYAT
19220008	20 / 80	365,00 TL

F 84

3'LÜ ANAHTARLI GOLYAT
NİLÜFER

KOD	KUTU / KOLİ	FİYAT
19310084	20 / 80	162,00 TL

F 18

3'LÜ FİŞ PRİZ
DELTA

KOD	KUTU / KOLİ	FİYAT
19310018	20 / 120	105,00 TL

F 45

2'Lİ FİŞ PRİZ
PAPATYA

KOD	KUTU / KOLİ	FİYAT
19210045	25 / 150	65,50

YENİ

F 27

3'LÜ FİŞ PRİZ
PAPATYA

KOD	KUTU / KOLİ	FİYAT
19310027	20 / 120	82,50 TL

F 63

3'LÜ FİŞ PRİZ
NİLÜFER

KOD	KUTU / KOLİ	FİYAT
19310063	24 / 144	82,50 TL

F 144

4'LÜ FİŞ PRİZ
PAPATYA

KOD	KUTU / KOLİ	FİYAT
19411144	20 / 80	132,00 TL

YENİ

F 156

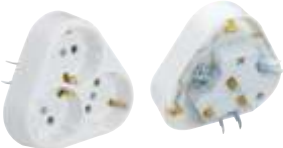
3'LÜ SIVA ALTI
TOPRAKLI PRİZ

KOD	KUTU / KOLİ	FİYAT
19310156	25 / 150	109,00 TL

F 333



2'Lİ ANAHTARLI GOLYAT

KOD	KUTU / KOLİ	FİYAT
19211333	20 / 120	141,00 TL

YENİ

F 334



3'LÜ ANAHTARLI GOLYAT

KOD	KUTU / KOLİ	FİYAT
19311334	20 / 80	182,00 TL

YENİ

F 335



4'LÜ ANAHTARLI GOLYAT

KOD	KUTU / KOLİ	FİYAT
19411335	20 / 80	197,00 TL

YENİ

F 13



3'LÜ T FİŞ

KOD	KUTU / KOLİ	FİYAT
19300013	50 / 500	26,50 TL

F 32



GOLYAT 5'Lİ FİŞ

KOD	KUTU / KOLİ	FİYAT
19500032	50 / 500	26,50 TL

F 71

İNGİLİZ ADAPTÖR
FİŞİ

KOD	KUTU / KOLİ	FİYAT
19100071	50 / 500	26,00 TL

F 149

ÜNİVERSAL
ADAPTÖR FİŞ

KOD	KUTU / KOLİ	FİYAT
19110001	50 / 500	58,50 TL



AKSESUAR SERİSİ

Turkey
Discover
the potential



F 999



UPS'Lİ TOPRAKLI
ERKEK FİŞ

KOD	KUTU / KOLİ	FİYAT
23020999	50 / 500	28,50 TL

F 998



TOPRAKLI
DİŞİ FİŞ

KOD	KUTU / KOLİ	FİYAT
23010998	50 / 300	32,50 TL

F 158



TOPRAKLI
ERKEK FİŞ

KOD	KUTU / KOLİ	FİYAT
23010158	50 / 500	28,50 TL

F 159



TOPRAKLI
DİŞİ FİŞ

KOD	KUTU / KOLİ	FİYAT
23010159	50 / 300	32,50 TL

F 16



ERKEK FİŞ
MIMOZA

KOD	KUTU / KOLİ	FİYAT
23000016	100 / 1000	21,00 TL

F 17



DİŞİ FİŞ
MIMOZA

KOD	KUTU / KOLİ	FİYAT
23000017	100 / 1000	21,00 TL

F 05



AMERİKAN
ADAPTÖR FİŞİ

KOD	KUTU / KOLİ	FİYAT
23200005	50 / 500	26,50 TL

F 31



DUY FİŞİ
(RENKLİ)

KOD	KUTU / KOLİ	FİYAT
23000031	50 / 500	19,40 TL

F 182



TOPRAKLI
KULPLU FİŞ

KOD	KUTU / KOLİ	FİYAT
23110182	50 / 500	31,80 TL

F 10



TOPRAKLI ERKEK FİŞ
YAN MODEL (BAKALİT)

KOD	KUTU / KOLİ	FİYAT
23310010	50 / 500	42,00 TL

F 28



MONOBLOK TOPRAKLI
ERKEK FİŞ

KOD	KUTU / KOLİ	FİYAT
23410028	50 / 500	27,60 TL

F 128



TOPRAKLI L FİŞ

KOD	KUTU / KOLİ	FİYAT
23110128	50 / 500	32,60 TL

F 43



YASSI
ERKEK FİŞ

KOD	KUTU / KOLİ	FİYAT
23200043	50 / 500	15,90 TL

F 44



YASSI
DİŞİ FİŞ

KOD	KUTU / KOLİ	FİYAT
23200044	50 / 500	15,90 TL

F 26



ARAPUAR
PLASTİK

KOD	KUTU / KOLİ	FİYAT
23000026	50 / 500	21,00 TL

F 47



ARAPUAR
SWITCH

KOD	KUTU / KOLİ	FİYAT
23000047	50 / 500	21,00 TL



AKSESUAR SERİSİ

Turkey
Discover
the potential



F 46



GENİŞ İŞIKLI
ANAHTAR

KOD	KUTU / KOLİ	FİYAT
23000046	50 / 500	40,50 TL

F 131



ANAHTARLI TOPRAKLI
ERKEK FİŞ (IŞIKLI)

KOD	KUTU / KOLİ	FİYAT
23111131	50 / 300	90,00 TL

F 134



ANAHTARLI ERKEK FİŞ
(KOLAY BAĞLANTILI)

KOD	KUTU / KOLİ	FİYAT
23111134	40 / 240	99,50 TL

F 135



TOPRAKLI ERKEK FİŞ
(KOLAY BAĞLANTILI)

KOD	KUTU / KOLİ	FİYAT
231110135	40 / 240	50,50 TL

F 72



E27 İTALYAN
DUY (DİŞLİ)

KOD	KUTU / KOLİ	FİYAT
23000072	100 / 600	22,50 TL

F 146



E27 İTALYAN
DUY (DÜZ)

KOD	KUTU / KOLİ	FİYAT
23000002	100 / 600	20,50 TL

F 12



E14 İTALYAN
DUY (DİŞLİ)

KOD	KUTU / KOLİ	FİYAT
23000012	100 / 600	20,50 TL

F 145



E14 İTALYAN
DUY (DÜZ)

KOD	KUTU / KOLİ	FİYAT
23000001	100 / 600	19,50 TL

F 14



ÜTÜ FİŞİ
TOPRAKLI

KOD	KUTU / KOLİ	FİYAT
23010014	50 / 500	54,00 TL

F 15



ÜTÜ FİŞİ
(NORMAL)

KOD	KUTU / KOLİ	FİYAT
23000015	50 / 500	48,00 TL

AKSESUAR
serisi



SIVA ALTI - SIVA ÜSTÜ SERİSİ

Turkey
Discover
the potential



F 66 SIVA ÜSTÜ ANAHTAR NEMLİYER IP44 KOD KUTU / KOLİ FİYAT 27000066 20 / 200 46,50 TL	F 68 SIVA ÜSTÜ KOMİTATÖR NEMLİYER IP44 KOD KUTU / KOLİ FİYAT 27020068 20 / 200 52,50 TL	F 70 SIVA ÜSTÜ TOPRAKLI PRİZ NEMLİYER IP44 KOD KUTU / KOLİ FİYAT 27011070 20 / 200 52,50 TL	F 83 SIVA ÜSTÜ KAPAKLI TOPRAKLI PRİZ NEMLİYER IP44 KOD KUTU / KOLİ FİYAT 27011083 20 / 200 58,50 TL
F 67 SIVA ÜSTÜ LIGHT NEMLİYER IP44 KOD KUTU / KOLİ FİYAT 27030067 20 / 200 49,00 TL	F 69 SIVA ÜSTÜ VAVIEN NEMLİYER IP44 KOD KUTU / KOLİ FİYAT 27040069 20 / 200 49,50 TL	F 129 SIVA ÜSTÜ TOPRAKLI PRİZ YUVARLAK KOD KUTU / KOLİ FİYAT 27011129 20 / 200 51,60 TL	F 85 SIVA ÜSTÜ TOPRAKSIZ PRİZ KOD KUTU / KOLİ FİYAT 27010085 20 / 200 49,50 TL
F 143 SIVA ALTI ANAHTARLI TOPRAKLI PRİZ KOD KUTU / KOLİ FİYAT 31112001 15 / 150 67,00 TL			

SIVA ALTI
SIVA ÜSTÜ
serisi



TEZGAHALTI GRUP PRİZLER

Turkey
Discover
the potential



F 210



ANTRASİT TEZGAH PRİZİ
PLASTİK PANELLİ

KOD	KUTU / KOLİ	FİYAT
51710210	1 / 24	682,50 TL

F 211



KROM TEZGAH PRİZİ
PLASTİK PANELLİ

KOD	KUTU / KOLİ	FİYAT
51710211	1 / 24	595,00 TL

F 212



SİYAH TEZGAH PRİZİ
PLASTİK PANELLİ

KOD	KUTU / KOLİ	FİYAT
51710212	1 / 24	612,50 TL

TEZGAHALTI
GRUP PRİZ
serisi

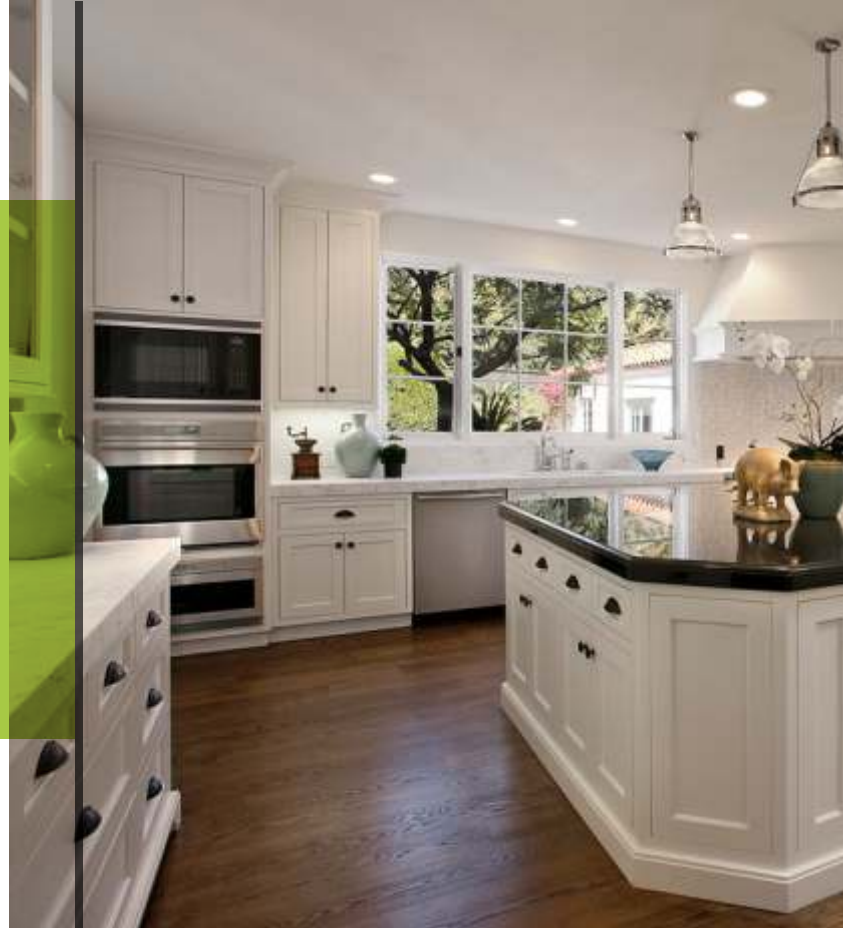

KAUÇUK SERİSİ

Turkey
Discover
the potential

F 48

1x16 KAUÇUK
ERKEK FİŞ

KOD	KUTU / KOLİ	FİYAT
37110048	50 / 300	32,80 TL

F 49

1x16 KAUÇUK
DIŞI FİŞ

KOD	KUTU / KOLİ	FİYAT
37110049	25 / 150	42,50 TL

F 161

1x16 KAUÇUK KULPLU
ERKEK FİŞ

KOD	KUTU / KOLİ	FİYAT
37111161	50 / 300	36,80 TL

F 106

1x16 MONOFAZE
TOPRAKLI DUVAR PRİZİ

KOD	KUTU / KOLİ	FİYAT
37100106	20 / 120	86,00 TL

F 160

1x16 KAUÇUK MONOFAZE
2'Lİ GRUP PRİZ

KOD	KUTU / KOLİ	FİYAT
37220160	10 / 60	124,00 TL

F 280

1x16 KAUÇUK MONOFAZE
3'LÜ GRUP PRİZ

KOD	KUTU / KOLİ	FİYAT
37326280	6 / 36	129,00 TL

F 288

1x16 KAUÇUK MONOFAZE
4'LÜ GRUP PRİZ

KOD	KUTU / KOLİ	FİYAT
37426288	20 / 80	162,00 TL

F 105

(3x25 2 ADET 1x16 1 ADET)
2 TRİFAZE
1 MONOFAZE GRUP PRİZ

KOD	KUTU / KOLİ	FİYAT
37324105	7 / 42	390,00 TL

F 136

3x25 3'LÜ
TRİFAZE GRUP PRİZ

KOD	KUTU / KOLİ	FİYAT
37327136	7 / 42	400,00 TL

F 137

(3x25 1 ADET 1x16 2 ADET)
1 TRİFAZE
2 MONOFAZE GRUP PRİZ

KOD	KUTU / KOLİ	FİYAT
37325137	7 / 42	390,00 TL

F 101

3x25 KAUÇUK
TRİFAZE FİŞ

KOD	KUTU / KOLİ	FİYAT
37111101	25 / 150	99,00 TL

F 102

3x25 KAUÇUK
TRİFAZE PRİZ

KOD	KUTU / KOLİ	FİYAT
37111102	20 / 120	125,00 TL

F 132

3x25 KAUÇUK
TRİFAZE DUVAR PRİZİ

KOD	KUTU / KOLİ	FİYAT
37101132	14 / 84	178,00 TL



AYDINLATMA ARMATÜRLERİ SERİSİ

Turkey
Discover
the potentialYERLİ
ÜRETİM

LED AMPÜL



YENİ	KOD	SİP. KODU	ÜRÜN ADI	KUTU / KOLİ	FİYAT
	F 810	46400810	9W Led Ampül	1 / 200	39,00 TL
	F 811	46400811	12W Led Ampül	1 / 200	58,00 TL
	F 812	46400812	15W Led Ampül	1 / 200	77,00 TL

TORCH AMPÜL



YENİ	KOD	SİP. KODU	ÜRÜN ADI	KUTU / KOLİ	FİYAT
	F 830	46400830	20W Led Torch Ampül	1 / 100	108,00 TL
	F 831	46400831	30W Led Torch Ampül	1 / 50	135,00 TL
	F 832	46400832	40W Led Torch Ampül	1 / 50	175,00 TL
	F 833	46400833	50W Led Torch Ampül	1 / 40	230,00 TL

60x60 PANEL LED



YENİ	KOD	SİP. KODU	ÜRÜN ADI	KUTU / KOLİ	FİYAT
	F 678	46400678	60x60 Backlight Led Panel 36W	1 / 10	775,00 tl

SIVA ÜSTÜ 60x60 PANEL
LED KASASI

YENİ	KOD	SİP. KODU	ÜRÜN ADI	KUTU / KOLİ	FİYAT
	F 679	46400679	60x60 Sıva Üstü Panel Led Kasası Demonte	1 / 30	135,00 TL
	F 680	46400680	60x60 Sıva Üstü Panel Led Kasası Montajlı	1 / 30	255,00 TL

BANT ARMATÜRLERİ



YENİ	KOD	SİP. KODU	ÜRÜN ADI	KUTU / KOLİ	FİYAT
	F 650	46400650	60 Cm Bant Armatür	2 / 30	174,00 TL
	F 651	46400651	120 Cm Bant Armatür	2 / 30	180,00 TL
	F 652	46400652	120 Cm Led Etanj Armatür	2 / 40	347,00 TL



AYDINLATMA ARMATÜRLERİ SERİSİ

Turkey
Discover
the potential

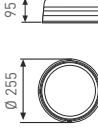

F 107

DEKORATİF TAVAN ARMATÜRÜ
(POLO)

KOD	KUTU / KOLİ	FİYAT
46010107	4 / 48	116,00 TL

F 162

DEKORATİF TAVAN ARMATÜRÜ
(PAPATYA)

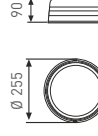
KOD	KUTU / KOLİ	FİYAT
46010162	4 / 48	116,00 TL

F 163



DEKORATİF TAVAN ARMATÜRÜ
(BÜYÜK KUMLU)

KOD	KUTU / KOLİ	FİYAT
46010163	4 / 48	116,00 TL

F 50A



DEKORATİF TAVAN ARMATÜRÜ
(YILDIZ)

KOD	KUTU / KOLİ	FİYAT
46010501	4 / 48	98,00 TL

F 50B

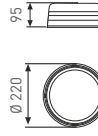
DEKORATİF TAVAN ARMATÜRÜ
(DAMLA)

KOD	KUTU / KOLİ	FİYAT
46010502	4 / 48	98,00 TL

F 207



DEKORATİF TAVAN ARMATÜRÜ
(KÜÇÜK KUMLU)

KOD	KUTU / KOLİ	FİYAT
46010207	4 / 48	91,00 TL

F 180



DEKORATİF TAVAN ARMATÜRÜ
(YAĞMUR)

KOD	KUTU / KOLİ	FİYAT
46010180	4 / 48	91,00 TL

F 109



DEKORATİF TAVAN ARMATÜRÜ
(EKO)

KOD	KUTU / KOLİ	FİYAT
46010109	4 / 48	91,00 TL

F 282



YILDIZ APLİK

KOD	KUTU / KOLİ	FİYAT
46210282	4 / 48	91,00 TL

F 51



İMAJ APLİK

KOD	KUTU / KOLİ	FİYAT
46020051	4 / 48	96,00 TL

F 701

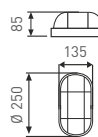
KAFESLİ
ARMATÜR

KOD	KUTU / KOLİ	FİYAT
46010701	10 / 40	106,00 TL

F 104

YARIM AY
APLİK

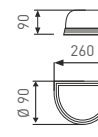
KOD	KUTU / KOLİ	FİYAT
46020104	4 / 48	103,00 TL



AYDINLATMA ARMATÜRLERİ SERİSİ

Turkey
Discover
the potential

YERLİ
ÜRETİM

F 103



MUHAFAZALI
TİJ TAKIMI

KOD	KUTU / KOLİ	FİYAT
46110103	50 / 300	25,70 TL

F 130



BADEM APLİK
(NEMLİ YER) IP 54

KOD	KUTU / KOLİ	FİYAT
46211130	4 / 48	232,00 TL

F 82



GALA MİNİ APLİK

KOD	KUTU / KOLİ	FİYAT
46010082	4 / 48	62,00 TL

F 179



DEKORATİF ÇİFT DUYLU TAVAN
ARMATÜRÜ (KUŞAKLI)

KOD	KUTU / KOLİ	FİYAT
46210179	1 / 10	245,00 TL

F 181



DEKORATİF ÇİFT DUYLU
TAVAN ARMATÜRÜ

KOD	KUTU / KOLİ	FİYAT
46010181	1 / 10	213,00 TL

AYDINLATMA
ARMATÜRLERİ
serisi



AYDINLATMA ARMATÜRLERİ SERİSİ

Turkey
Discover
the potential



SENSÖRLÜ LEDLİ TAVAN ARMATÜRLERİ



YENİ	KOD	SİP. KODU	ÜRÜN ADI	KUTU / KOLİ	FİYAT
	F 710	46040710	Sensörlü Armatür E27 Duyulu (Metal Kasa)	1 / 12	415,00 TL
	F 715	46042715	Sensörlü Armatür Acil Kitli 2xE27 (Metal Kasa)	1 / 12	700,00 TL
	F 716	46031716	Sensörlü Armatür 18W Ledli (Metal Kasa)	1 / 12	510,00 TL
	F 714	46041714	Sensörlü Armatür Full Ledli 18W (Metal Kasa)	1 / 12	790,00 TL
	F 710P	46040710P	Sensörlü Armatür E27 Duyulu (Plastik Kasa)	1 / 12	362,00 TL
	F 715P	46042715P	Sensörlü Armatür Acil Kitli 2xE27 (Plastik Kasa)	1 / 12	645,00 TL
	F 716P	46031716P	Sensörlü Armatür 18W Ledli (Plastik Kasa)	1 / 12	455,00 TL
	F 714P	46041714P	Sensörlü Armatür Full Ledli 18W (Plastik Kasa)	1 / 12	735,00 TL

SENSÖRLÜ LEDLİ DUVAR ARMATÜRLERİ



YENİ	KOD	SİP. KODU	ÜRÜN ADI	KUTU / KOLİ	FİYAT
	F 711	46030711	Sensörlü Duvar Aplik	1 / 18	388,00 TL
	F 713	46032713	Sensörlü Duvar Aplik Acil Kitli	1 / 18	615,00 TL
	F 712	46031712	Ledli Hareket Sensörlü Aplik	1 / 18	510,00 TL
	F 717	46033717	Ledli Hareket Sensörlü Aplik Acil Kitli	1 / 18	750,00 TL

ÜRÜN ÖZELLİKLERİ

Montaj Tipi Installation Type	Sıva Üstü Surface Mounted
Montaj Yeri Installation Location	Girintisiz Tavan - Girintisiz Duvar Ceiling Without Recess - Wall Without Recess
Aydınlatma Açısı Lighting Angle	Geniş (360°) Wide (360°)
Aydınlatma Türü Lighting Type	Max. 2x25W E27 - LED
Zaman Ayarı Time Setting	10 sn. ± 1 sn. / 5 dak. ± 10 sn. 10 sec. ± 1 sec. / 5 min. ± 10 sec.

ÜRÜN ÖZELLİKLERİ

Renk Geriverim Endeksi Colour Rendering Index	Ra >90 - Gün Işığı (3200K) - Beyaz Işık (6500K) Warm White (3200K) - White (6500K)
Koruma Derecesi Protection Class	Ip20 Class I (İç Mekan)
Armatür Rengi Luminaire Colour	Beyaz White
Çalışma Modu Operating Mode	Sensörlü With Sensor
Ek Ekipman Additional Equipment	Acil Kitli Tek Akü Sistemi, 3 Saat Single Battery System With Emergency Kit, 3 Hours



AYDINLATMA ARMATÜRLERİ SERİSİ

Turkey
Discover
the potential

YERLİ
ÜRETİM

AYDINLATMA ARMATÜRLERİ



KOD	SİP KODU	ÜRÜN ADI	KUTU / KOLİ	FİYAT
F 757	46030757	Sıva Altı Hareket Sensörü	1 / 24	325,00 TL
F 758	46030758	Sıva Üstü Hareket Sensörü	1 / 36	350,00 TL

ÜRÜN ÖZELLİKLERİ

Ürün Ölçüleri Product Size	Sıva Üstü - 80x80x50 Sıva Altı - 100x100x60
Montaj Tipi Installation Type	Sıva Üstü - Surface Mounted Sıva Altı - Surface Mounter
Montaj Yeri Installation Location	Girintisiz Tavan - Girintisiz Duvar Ceiling Without Recess - Wall Without Recess
Algılama Açısı Detection Angle	Geniş (360°) Wide (360°)
Koruma Derecesi Protection Class	IP20 Class I (İç Mekan)

ÜRÜN ÖZELLİKLERİ

Koruma Derecesi Protection Class	Ip20 Class I (İç Mekan)
Çalışma Modu Operating Mode	Sensörlü - Radar Sensörlü With Sensor - With Radar Sensor
Ek Ekipman Additional Equipment	Montaj Sabitleme Aparatı Mounting Fixing Parts
Zaman Ayarı Time Setting	10 sn ± 1 sn / 5 dk ± 10 sn 10 sec ± 1 sec / 5 min ± 10 sec

LEDLİ TAVAN ARMATÜRLERİ



KOD	SİP KODU	ÜRÜN ADI	KUTU / KOLİ	FİYAT
F 745	46030745	18W Okyanus Ledli Arm. Beyaz Kasa (3200K)	1 / 40	210,00 TL
F 746	46030746	18W Okyanus Ledli Arm. Beyaz Kasa (6500K)	1 / 40	210,00 TL
F 747	46030747	18W Okyanus Ledli Arm. Siyah Kasa (3200K)	1 / 40	210,00 TL
F 748	46030748	18W Okyanus Ledli Arm. Siyah Kasa (6500K)	1 / 40	210,00 TL
F 749	46030749	12W Ledli Arm. Şişirme Plastik Cam (3200K)	1 / 20	330,00 TL
F 750	46030750	12W Ledli Arm. Şişirme Plastik Cam (6500K)	1 / 20	330,00 TL
F 751	46030751	18W Ledli Arm. Şişirme Plastik Cam (3200K)	1 / 12	485,00 TL
F 752	46030752	18W Ledli Arm. Şişirme Plastik Cam (6500K)	1 / 12	485,00 TL
F 753	46030753	24W Ledli Arm. Şişirme Plastik Cam (3200K)	1 / 10	550,00 TL
F 754	46030754	24W Ledli Arm. Şişirme Plastik Cam (6500K)	1 / 10	550,00 TL
F 755	46030755	24W Ledli Arm. Kare Şişirme Plastik Cam (3200K)	1 / 10	525,00 TL
F 756	46030756	24W Ledli Arm. Kare Şişirme Plastik Cam (6500K)	1 / 10	525,00 TL

ÜRÜN ÖZELLİKLERİ

Ürün Ölçüleri Product Size	18W Okyanus - 220x220x60 12W Şişirme - 230x230x55 18W Şişirme - 300x300x55 24W Şişirme - 350x350x55 24W Kare - 300x300x45 15W Ledli - 220x220x60
Montaj Tipi Installation Type	Sıva Üstü Surface Mounted
Montaj Yeri Installation Location	Girintisiz Tavan - Girintisiz Duvar Ceiling Without Recess - Wall Without Recess
Aydınlatma Açısı Lighting Angle	Geniş (360°) Wide (360°)

ÜRÜN ÖZELLİKLERİ

Renk Geriverim Endeksi Colour Rendering Index	Ra > 90 - Gün Işığı (3200K) - Beyaz Işık (6500K) Warm White (3200K) - White (6500K)
Koruma Derecesi Protection Class	Ip20 Class I (İç Mekan)
Armatür Rengi Luminaire Colour	Beyaz - Siyah White - Black
Aydınlatma Türü Lighting Type	LED
Ek Ekipman Additional Equipment	Acil Kitli Tek Akü Sistemi, 3 Saat Single Battery System With Emergency Kit, 3 Hours



AYDINLATMA ARMATÜRLERİ SERİSİ

Turkey
Discover
the potential



F 669 **YENİ**



BAHÇE ARMATÜRÜ
KAFESLİ APLİK

KOD	KUTU / KOLİ	FİYAT
46400669	1 / 24	194,00 TL

F 670 **YENİ**



BAHÇE ARMATÜRÜ
KAFESLİ SET ÜSTÜ

KOD	KUTU / KOLİ	FİYAT
46400670	1 / 24	186,00 TL

F 671 **YENİ**



BAHÇE ARMATÜRÜ
KAFESLİ ZİNCİRLİ TOP

KOD	KUTU / KOLİ	FİYAT
46400671	1 / 24	222,00 TL

F 672 **YENİ**



BAHÇE ARMATÜRÜ
YARI KAFESLİ APLİK

KOD	KUTU / KOLİ	FİYAT
46400672	1 / 24	194,00 TL

F 673 **YENİ**



BAHÇE ARMATÜRÜ
YARI KAFESLİ SET ÜSTÜ

KOD	KUTU / KOLİ	FİYAT
46400673	1 / 24	186,00 TL

F 674 **YENİ**



BAHÇE ARMATÜRÜ
YARI KAFESLİ ZİNCİRLİ TOP

KOD	KUTU / KOLİ	FİYAT
46400674	1 / 24	222,00 TL

F 675 **YENİ**



BAHÇE ARMATÜRÜ
APLİK

KOD	KUTU / KOLİ	FİYAT
46400675	1 / 24	194,00 TL

F 676 **YENİ**



BAHÇE ARMATÜRÜ
SET ÜSTÜ

KOD	KUTU / KOLİ	FİYAT
46400676	1 / 24	186,00 TL

F 677 **YENİ**



BAHÇE ARMATÜRÜ
ZİNCİRLİ TOP

KOD	KUTU / KOLİ	FİYAT
46400677	1 / 24	222,00 TL

F 647 **YENİ**



KÜP BAHÇE
ARMATÜRÜ KASALI

KOD	KUTU / KOLİ	FİYAT
46400647	1 / 16	347,00 TL

F 648 **YENİ**



KÜP BAHÇE
ARMATÜRÜ ÇİTALı KASALI

KOD	KUTU / KOLİ	FİYAT
46400648	1 / 16	347,00 TL

F 649 **YENİ**



KÜP BAHÇE
ARMATÜRÜ

KOD	KUTU / KOLİ	FİYAT
46400649	1 / 16	345,00 TL



AYDINLATMA ARMATÜRLERİ SERİSİ

Turkey
Discover
the potential.

YERLİ
ÜRETİM

F 164 **YENİ**



ÇİFT YÖNLÜ
APLİK

KOD	KUTU / KOLİ	FİYAT
46010164	1 / 46	158,00 TL

F 165 **YENİ**



LALE BAHÇE ARMATÜRÜ
SET ÜSTÜ

KOD	KUTU / KOLİ	FİYAT
46020165	2 / 16	178,00 TL

F 166 **YENİ**



LALE BAHÇE ARMATÜRÜ
DUVAR APLİK

KOD	KUTU / KOLİ	FİYAT
46020166	2 / 16	178,00 TL

F 661 **YENİ**



DIŞ MEKAN LED
ARMATÜR YUVARLAK 18W

KOD	KUTU / KOLİ	FİYAT
46400661	4 / 16	246,00 TL

F 662 **YENİ**



DIŞ MEKAN LED
ARMATÜR YUVARLAK 15W

KOD	KUTU / KOLİ	FİYAT
46400662	4 / 32	230,00 TL

F 663 **YENİ**



DIŞ MEKAN
LED ARMATÜR

KOD	KUTU / KOLİ	FİYAT
46400663	4 / 32	232,00 TL

F 664 **YENİ**



DIŞ MEKAN LED
ARMATÜR OVAL 15W

KOD	KUTU / KOLİ	FİYAT
46400664	4 / 32	220,00 TL

F 653 **YENİ**



DIŞ MEKAN LED
ARMATÜR OVAL KAFESLİ 15W

KOD	KUTU / KOLİ	FİYAT
46400653	4 / 32	223,00 TL

F 654 **YENİ**



DIŞ MEKAN LED
ARMATÜR KARE 15W

KOD	KUTU / KOLİ	FİYAT
46400654	4 / 32	246,00 TL

F 655 **YENİ**



DIŞ MEKAN LED
ARMATÜR KARE ÇİTALİ 15W

KOD	KUTU / KOLİ	FİYAT
46400655	4 / 32	246,00 TL

F 656 **YENİ**



DIŞ MEKAN LED
ARMATÜR KARE DESENİ 15W

KOD	KUTU / KOLİ	FİYAT
46400656	4 / 32	246,00 TL

ACİL YÖNLENDİRME ARMATÜRLERİ

Turkey
Discover
the potential



ACİL YÖNLENDİRME ARMATÜRLERİ



YENİ



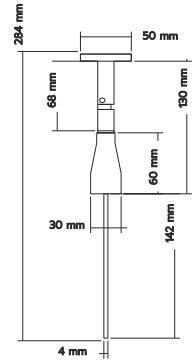
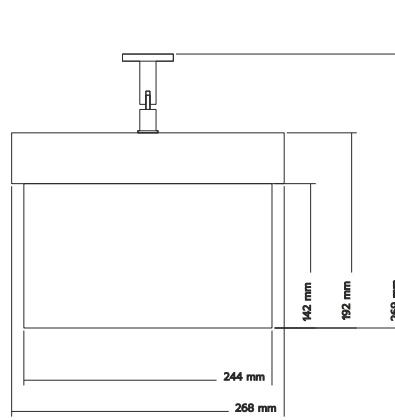















KOD	SİP. KODU	ÜRÜN ADI	KUTU / KOLİ	FİYAT
XXX	55000XXX	Acil Yönlendirme Armatürü	20 / 20	585,00 TL
F 681	55000681	Acil Yönlendirme Sıva Altı Montaj Aparatı	20 / 20	480,00 TL



ACİL
YÖNLENDİRME
serisi



ACIL YÖNLENDİRME ARMATÜRLERİ

 F602 55000602	 F603 55000603	 F604 55000604	 F605 55000605	 F606 55000606	 F607 55000607	 F608 55000608
 F609 55000609	 F610 55000610	 F611 55000611	 F612 55000612	 F613 55000613	 F614 55000614	 F615 55000615
 F616 55000616	 F617 55000617	 F618 55000618	 F619 55000619	 F620 55000620	 F621 55000621	 F622 55000622
 F623 55000623	 F624 55000624	 F625 55000625	 F626 55000626	 F627 55000627	 F628 55000628	 F629 55000629
 F630 55000630	 F631 55000631	 F632 55000632	 F633 55000633	 F634 55000634	 F635 55000635	 F636 55000636
 F637 55000637	 F638 55000638	 F639 55000639	 F640 55000640	 F641 55000641	 F642 55000642	 F643 55000643

PLASTİK MALZEME SERİSİ

Turkey
Discover
the potential



PLASTİK KABLO BAĞI SİYAH / BEYAZ



KOD	SİP. KODU	ÜRÜN ADI	ÇAP	POŞET	KOLİ	FİYAT
F 340	57125100	2.5x100 Plastik Kablo Bağı	24 mm	100	50.000	0,320 TL
F 341	57125150	2.5x150 Plastik Kablo Bağı	40 mm	100	40.000	0,457 TL
F 342	57125200	2.5x200 Plastik Kablo Bağı	55 mm	100	25.000	0,571 TL
F 343	57136150	3.6x150 Plastik Kablo Bağı	40 mm	100	25.000	0,617 TL
F 344	57136200	3.6x200 Plastik Kablo Bağı	55 mm	100	20.000	0,789 TL
F 345	57136250	3.6x250 Plastik Kablo Bağı	68 mm	100	18.000	0,903 TL
F 346	57136300	3.6x300 Plastik Kablo Bağı	82 mm	100	17.000	1,040 TL
F 347	57136370	3.6x370 Plastik Kablo Bağı	102 mm	100	15.000	1,257 TL
F 348	57148200	4.8x200 Plastik Kablo Bağı	55 mm	100	18.000	1,040 TL
F 349	57148250	4.8x250 Plastik Kablo Bağı	68 mm	100	15.000	1,200 TL
F 350	57148300	4.8x300 Plastik Kablo Bağı	82 mm	100	14.000	1,657 TL
F 351	57148380	4.8x380 Plastik Kablo Bağı	110 mm	100	12.000	1,909 TL
F 352	57148450	4.8x450 Plastik Kablo Bağı	130 mm	100	9.000	2,263 TL
F 353	57148500	4.8x500 Plastik Kablo Bağı	160 mm	100	7.000	2,457 TL
F 354	57180300	8.0x300 Plastik Kablo Bağı	82 mm	100	6.000	3,406 TL
F 355	57180380	8.0x380 Plastik Kablo Bağı	110 mm	100	5.000	3,680 TL
F 356	57180450	8.0x450 Plastik Kablo Bağı	133 mm	100	4.500	4,137 TL
F 357	57180550	8.0x550 Plastik Kablo Bağı	166 mm	100	3.000	5,623 TL
F 358	57180650	8.0x650 Plastik Kablo Bağı	192 mm	100	2.500	6,480 TL
F 359	57180750	8.0x750 Plastik Kablo Bağı	235 mm	100	2.500	7,178 TL

PLASTİK KABLO BAĞI



PLASTİK MALZEME SERİSİ

Turkey
Discover
the potential

YERLİ
ÜRETİM

ÇİVİLİ KROŞE



KOD	SİP. KODU	ÜRÜN ADI	KUTU	AMBALAJ	KOLİ	FİYAT
F 110	57100110	Kroşe No: 0	100	1.000	20.000	0,45 TL
F 111	57100111	Kroşe No: 1	100	1.000	20.000	0,45 TL
F 112	57100112	Kroşe No: 2	100	1.000	20.000	0,45 TL
F 113	57100113	Kroşe No: 3	100	1.000	20.000	0,58 TL
F 114	57100114	Kroşe No: 4	100	1.000	20.000	0,58 TL
F 115	57100115	Kroşe No: 5	100	1.000	10.000	0,91 TL
F 116	57100116	Kroşe No: 6	100	1.000	10.000	0,91 TL
F 117	57100117	Kroşe No: 7	100	1.000	3000	1,74 TL
F 118	57100118	Kroşe No: 8	100	1.000	2000	2,20 TL

SIRA KLEMENS

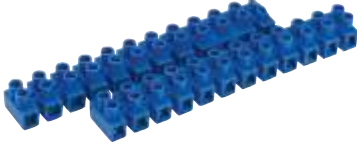

KOD	SİP. KODU	ÜRÜN ADI	KUTU / KOLİ	FİYAT
F 151	57100151	Sıra Klemens No: 1	50 / 1.000	38,30 TL
F 152	57100152	Sıra Klemens No: 2	50 / 1.000	45,60 TL
F 153	57100153	Sıra Klemens No: 3	50 / 500	54,70 TL
F 154	57100154	Sıra Klemens No: 4	50 / 500	65,60 TL
F 155	57100155	Sıra Klemens No: 5	50 / 500	79,60 TL

SIRA KLEMENS YANMAZ



KOD	SİP. KODU	ÜRÜN ADI	KUTU / KOLİ	FİYAT
F 174	57110174	Sıra Klemens Yanmaz No: 1	50 / 1.000	43,70 TL
F 175	57110175	Sıra Klemens Yanmaz No: 2	50 / 1.000	51,00 TL
F 176	57110176	Sıra Klemens Yanmaz No: 3	50 / 500	62,00 TL
F 177	57110177	Sıra Klemens Yanmaz No: 4	50 / 500	73,00 TL
F 178	57110178	Sıra Klemens Yanmaz No: 5	50 / 500	91,00 TL

PLASTİK DÜBEL



KOD	SİP. KODU	ÜRÜN ADI	KUTU / KOLİ	FİYAT
F 55 A	57205506	Plastik Dübel 6 mm	1.000 / 30.000	0,285 TL
F 55 B	57205507	Plastik Dübel 7 mm	1.000 / 25.000	0,290 TL
F 55 C	57205508	Plastik Dübel 8 mm	1.000 / 20.000	0,307 TL
F 55 D	57205510	Plastik Dübel 10 mm	1.000 / 10.000	0,481 TL

PLASTİK ZİL BUTONLARI



YENİ

KOD	SİP. KODU	ÜRÜN ADI	KUTU / KOLİ	FİYAT
F 477	56000477	1'li Plastik Zil Butonu	1 / 20	54,60 TL
F 478	56000478	2'li Plastik Zil Buton	1 / 20	91,00 TL
F 479	56000479	3'lü Plastik Zil Butonu	1 / 20	137,00 TL
F 480	56000480	4'lü Plastik Zil Butonu	1 / 20	182,00 TL

ALÜMİNYUM ZİL BUTONLARI



YENİ

KOD	SİP. KODU	ÜRÜN ADI	KUTU / KOLİ	FİYAT
F 481	56100481	1'li Alüminyum Zil Butonu	1 / 20	81,00 TL
F 482	56100482	2'li Alüminyum Zil Butonu	1 / 20	163,00 TL
F 483	56100483	3'lü Alüminyum Zil Butonu	1 / 20	243,00 TL
F 484	56100484	4'lü Alüminyum Zil Butonu	1 / 20	325,00 TL
F 485	56100485	5'li Alüminyum Zil Butonu	1 / 20	406,00 TL
F 486	56100486	6'li Alüminyum Zil Butonu	1 / 20	487,00 TL
F 487	56100487	7'li Alüminyum Zil Butonu	1 / 20	568,00 TL
F 488	56100488	8'li Alüminyum Zil Butonu	1 / 10	650,00 TL
F 489	56100489	9'lu Alüminyum Zil Butonu	1 / 10	730,00 TL
F 490	56100490	10'lu Alüminyum Zil Butonu	1 / 10	810,00 TL



KABLO KANALLARI SERİSİ

Turkey
Discover
the potential



KOD	SİP. KODU	ÜRÜN ADI	KUTU / KOLİ	Mt./FİYAT
F 213	58001212	12 X 12 Kablo Kanalı	2 / 484 Mt.	11,55 TL
F 214	58001510	15 X 10 Kablo Kanalı	2 / 300 Mt.	12,01 TL
F 215	58001616	16 X 16 Kablo Kanalı	2 / 288 Mt.	13,06 TL
F 216	58002010	20 X 10 Kablo Kanalı	2 / 240 Mt.	15,98 TL
F 217	58002516	25 X 16 Kablo Kanalı	2 / 160 Mt.	19,36 TL
F 218	58002525	25 X 25 Kablo Kanalı	2 / 100 Mt.	25,89 TL
F 219	58004016	40 X 16 Kablo Kanalı	2 / 84 Mt.	33,63 TL
F 220	58004025	40 X 25 Kablo Kanalı	2 / 112 Mt.	31,09 TL
F 221	58004040	40 X 40 Kablo Kanalı	2 / 70 Mt.	40,31 TL
F 222	58006040	60 X 40 Kablo Kanalı	2 / 48 Mt.	73,18 TL
F 223	58006060	60 X 60 Kablo Kanalı	2 / 40 Mt.	94,23 TL
F 224	58008040	80 X 40 Kablo Kanalı	2 / 36 Mt.	96,89 TL
F 225	58008060	80 X 60 Kablo Kanalı	2 / 32 Mt.	103,18 TL
F 226	58010040	100 X 40 Kablo Kanalı	2 / 28 Mt.	108,02 TL
F 227	58010060	100 X 60 Kablo Kanalı	2 / 24 Mt.	117,09 TL

KABLO KANALI



KOD	SİP. KODU	ÜRÜN ADI	KUTU / KOLİ	Mt./FİYAT
F 228	58101212	12 X 12 Yapışkanlı Kablo Kanalı	2 / 484 MT.	13,06 TL
F 229	58101510	15 X 10 Yapışkanlı Kablo Kanalı	2 / 300 MT.	14,11 TL
F 230	58101616	16 X 16 Yapışkanlı Kablo Kanalı	2 / 288 MT.	15,16 TL
F 231	58102010	20 X 10 Yapışkanlı Kablo Kanalı	2 / 240 MT.	19,01 TL
F 232	58102516	25 X 16 Yapışkanlı Kablo Kanalı	2 / 160 MT.	23,21 TL
F 233	58102525	25 X 25 Yapışkanlı Kablo Kanalı	2 / 100 MT.	29,88 TL
F 234	58104016	40 X 16 Yapışkanlı Kablo Kanalı	2 / 84 MT.	39,80 TL
F 235	58104025	40 X 25 Yapışkanlı Kablo Kanalı	2 / 112 MT.	38,25 TL
F 236	58104040	40 X 40 Yapışkanlı Kablo Kanalı	2 / 70 MT.	45,20 TL

KABLO KANALI YAPIŞKANLI

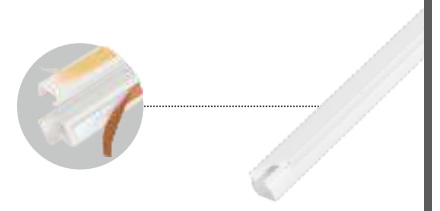

KOD	SİP. KODU	ÜRÜN ADI	KUTU / KOLİ	FİYAT
F 800	59000800	100'lük Banyo Aspiratörü 12 Watt	1 / 20	445,00 TL
F 801	59000801	120'lik Banyo Aspiratörü 15 Watt	1 / 20	475,00 TL
F 802	59000802	150'lik Banyo Aspiratörü 20 Watt	1 / 10	583,00 TL

ASPIRATÖRLER



KOD	SİP. KODU	ÜRÜN ADI	KUTU / KOLİ	FİYAT
F 168	57050168	Plastik Susta 10 Mt.	1 / 25	163,00 TL
F 169	57050169	Plastik Susta 15 Mt.	1 / 20	245,00 TL
F 170	57050170	Plastik Susta 20 Mt.	1 / 15	327,00 TL
F 171	57050171	Plastik Susta 25 Mt.	1 / 13	410,00 TL

PLASTİK SUSTA



KOD	SİP. KODU	ÜRÜN ADI	KUTU / KOLİ	FİYAT
F 262	57050262	Çelik Susta 10 Mt.	1 / 25	250,00 TL
F 263	57050263	Çelik Susta 15 Mt.	1 / 20	364,00 TL
F 264	57050264	Çelik Susta 20 Mt.	1 / 15	477,00 TL
F 265	57050265	Çelik Susta 25 Mt.	1 / 13	568,00 TL
F 266	57050266	Çelik Susta 30 Mt.	1 / 10	682,00 TL

ÇELİK SUSTA



SİGORTA KUTULARI SERİSİ

Turkey
Discover
the potentialYERLİ
ÜRETİM

F 98

1 - 2'Lİ
SİGORTA KUTUSU

KOD	KUTU / KOLİ	FİYAT
65000002	40 / 40	26,00 TL

F 99

3 - 4'LÜ
SİGORTA KUTUSU

KOD	KUTU / KOLİ	FİYAT
65000004	25 / 25	36,60 TL

F 148

2'Lİ SIVA ÜSTÜ
SİGORTA KUTUSU

KOD	KUTU / KOLİ	FİYAT
65001002	1 / 30	101,00 TL

F 147

2'Lİ SIVA ALTI
SİGORTA KUTUSU

KOD	KUTU / KOLİ	FİYAT
61001002	1 / 30	101,00 TL

F 86

6'Lİ SIVA ÜSTÜ
SİGORTA KUTUSU

KOD	KUTU / KOLİ	FİYAT
65001006	1 / 30	143,00 TL

F 87

6'Lİ SIVA ALTI
SİGORTA KUTUSU

KOD	KUTU / KOLİ	FİYAT
61001006	1 / 30	143,00 TL

F 88

9'LU SIVA ÜSTÜ
SİGORTA KUTUSU

KOD	KUTU / KOLİ	FİYAT
65001009	1 / 20	191,00 TL

F 89

9'LU SIVA ALTI
SİGORTA KUTUSU

KOD	KUTU / KOLİ	FİYAT
61001009	1 / 20	191,00 TL

F 90

12'Lİ SIVA ÜSTÜ
SİGORTA KUTUSU

KOD	KUTU / KOLİ	FİYAT
65001012	1 / 20	245,00 TL

F 91

12'Lİ SIVA ALTI
SİGORTA KUTUSU

KOD	KUTU / KOLİ	FİYAT
61001012	1 / 20	245,00 TL

F 92

16'Lİ SIVA ÜSTÜ
SİGORTA KUTUSU

KOD	KUTU / KOLİ	FİYAT
65001016	1 / 20	300,00 TL

F 93

16'Lİ SIVA ALTI
SİGORTA KUTUSU

KOD	KUTU / KOLİ	FİYAT
61001016	1 / 20	300,00 TL

F 94

24'LÜ SIVA ÜSTÜ
SİGORTA KUTUSU

KOD	KUTU / KOLİ	FİYAT
65001024	1 / 10	385,00 TL

F 95

24'LÜ SIVA ALTI
SİGORTA KUTUSU

KOD	KUTU / KOLİ	FİYAT
61001024	1 / 10	385,00 TL

F 96

36'Lİ SIVA ÜSTÜ
SİGORTA KUTUSU

KOD	KUTU / KOLİ	FİYAT
65001036	1 / 10	550,00 TL

F 97

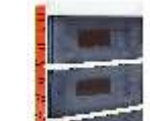
36'Lİ SIVA ALTI
SİGORTA KUTUSU

KOD	KUTU / KOLİ	FİYAT
61001036	1 / 10	550,00 TL



SANAYİ TİP SERİSİ

Turkey
Discover
the potential



F 172



TRİFAZE
PANO PRİZİ

KOD	KUTU / KOLİ	FİYAT
70001172	20 / 120	107,00 TL

F 173



MONOFAZE
PANO PRİZİ

KOD	KUTU / KOLİ	FİYAT
70001173	50 / 500	57,00 TL

F 41



TRİFAZE
FİŞ

KOD	KUTU / KOLİ	FİYAT
27151041	24 / 240	100,00 TL

F 42



TRİFAZE
PRİZ

KOD	KUTU / KOLİ	FİYAT
27111042	16 / 160	128,00 TL

F 281



UZATMA KABLO MAKARASI

KOD	KUTU / KOLİ	FİYAT
70004281	1 / 4	488,00 TL

F 11



GEÇMELİ
DERİN KASA

KOD	KUTU / KOLİ	FİYAT
57320011	100 / 1000	6,50 TL

F 133



GEÇMELİ
ALÇIPAN KASA

KOD	KUTU / KOLİ	FİYAT
57310133	100 / 1000	13,80 TL

F 54



PLASTİK
BUAT KAPAĞI (BOMBELİ)

KOD	KUTU / KOLİ	FİYAT
57440054	100 / 2000	4,60 TL

F 65



KARE BUAT
(85x85)

KOD	KUTU / KOLİ	FİYAT
57430065	20 / 240	23,00 TL

F 119



KARE BUAT
(110x110)

KOD	KUTU / KOLİ	FİYAT
57430119	8 / 96	63,60 TL

F 330



DÜZ KONTROL KALEMİ

KOD	KUTU / KOLİ	FİYAT
57110330	24 / 240	38,50 TL

F 331



TOPAÇ KONTROL KALEMİ

KOD	KUTU / KOLİ	FİYAT
57110331	20 / 200	42,00 TL

F 332



CEP TİPİ KONTROL KALEMİ

KOD	KUTU / KOLİ	FİYAT
57110332	30 / 300	34,60 TL





www.far-electric.com.tr

NOTLAR

A series of horizontal dotted lines for writing notes.



FAR®
ELEKTRİK TEKNOLOJİLERİ A.Ş.



www.far-electric.com.tr